

PMA SERIES BRUSHLESS SERVOMOTORS

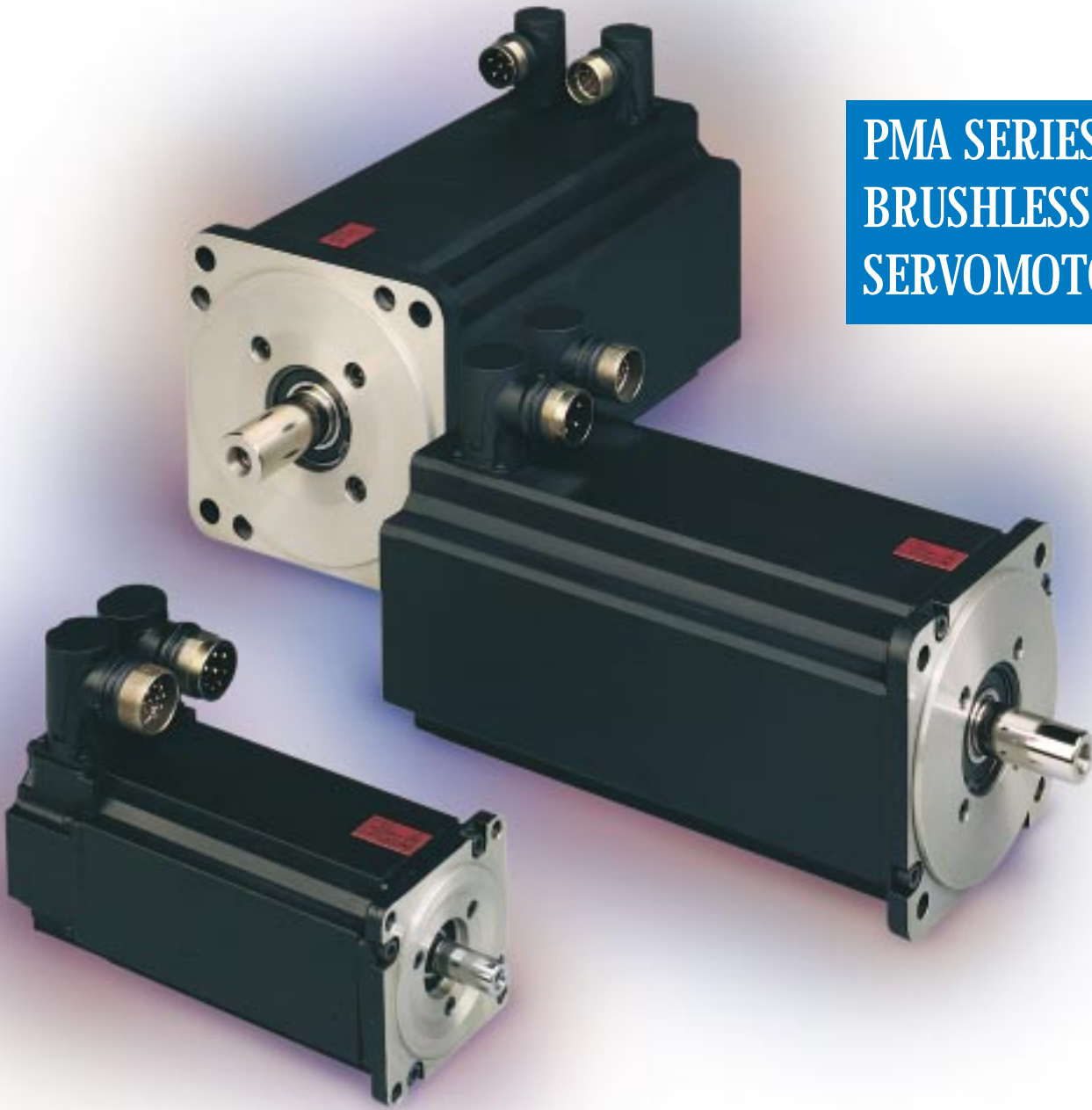

Unmatched Ruggedness & Cost Effectiveness in a Comprehensive Family of Brushless Servomotors

Pacific Scientific's new wide voltage range (from 240 to 480V ac) PMA Series is industry's most rugged, comprehensive line of reliable, customizable and cost-effective brushless servomotors.

Rugged construction earns IP67 rating (on selected models) and enhances your equipment reliability. CE compliance and medium-voltage capability open the door to a world-wide range

of applications. Making the PMA Series the ultimate cost-effective choice for your motion control needs.

This line extends Pacific Scientific's commitment to offering you the highest performance products, backed by unmatched customer support and quality, with an ability to offer custom products to fit your unique applications.



DRIVE & MOTOR PERFORMANCE DATA

In the table below, performance data for combinations of PMA Series motors and SCE900 or SC900 drives are shown. In addition to continuous stall current (I_{CS}), inertia (J) and line-line inductance (L), each system has ratings provided that enable you to construct a reference chart for in comparing and sizing systems. The ratings required to construct the chart are:

- Peak Stall Torque (T_{PS})
- Peak Rated Torque (T_{PR})
- Continuous Stall Torque (T_{CS})
- Continuous Rated Torque (T_{CR})
- Rate Speed (W_R)
- Motor Speed Unloaded (W_{NL})

To construct a chart, plot the points as in the example shown. Note that the chart provides continuous and intermittent duty zones.

Systems can be operated continually at torque/speed combinations anywhere in the continuous duty area, assuming the ambient temperature is less than 40°C.

Operation in the intermittent duty zone must be limited to a duty cycle which will produce an RMS system torque falling within the continuous duty area. The RMS torque value is defined by the magnitude of the intermittent torque and the percentage of time spent at that torque.

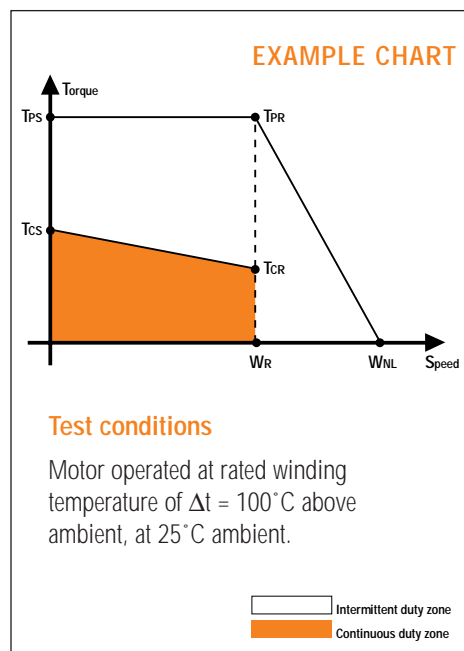

Servo Drive Model	Servo Motor Model	Peak stall torque T_{PS} lb-in./Nm	Peak rated torque T_{PR} lb-in./Nm	Cont. stall torque T_{CS} lb-in./Nm	Cont. rated torque T_{CR} lb-in./Nm	Rated speed W_R rpm	No-load speed W_{NL} rpm	Motor Weight lb-in./kg.	Current at peak torque I_{PK} A	Inertia $\times 10^3$ J lb-in.-S ² / kgm ²
240V ac										
SC902-AN-001-01	PMA21B-00100-00	16.8/1.9	16.8/1.9	5.6/0.63	4.4/0.50	6,050	9,250	3.3/1.5	5.4	0.23/0.026
SCE902-AN-001-01	PMA21B-00100-00	16.8/1.9	16.8/1.9	5.6/0.63	4.4/0.50	6,050	9,250	3.3/1.5	5.4	0.23/0.026
SC902-AN-001-01	PMA22B-00100-00	23.2/2.6	23.2/2.6	11.5/1.3	8.9/1.0	5,750	7,100	4.6/2.1	5.4	0.38/0.044
SCE902-AN-001-01	PMA22B-00100-00	23.2/2.6	23.2/2.6	11.5/1.3	8.9/1.0	5,750	7,100	4.6/2.1	5.4	0.38/0.044
SC903-AN-001-01	PMA23D-00100-00	37.2/4.2	37.2/4.2	17.7/2.0	11.5/1.3	7,400	8,750	5.9/2.7	10.6	0.55/0.062
SCE903-AN-001-01	PMA24D-00100-00	46.9/5.3	46.9/5.3	23.0/2.6	16.1/1.8	5,850	6,950	7.3/3.3	10.6	0.71/0.08
SC902-AN-001-01	PMA42M-00100-00	69.9/7.9	69.9/7.9	36.3/4.1	34.5/3.9	1,600	2,350	13.2/6	5.4	3.1/0.35
SCE902-AN-001-01	PMA42M-00100-00	69.9/7.9	69.9/7.9	36.3/4.1	34.5/3.9	1,600	2,350	13.2/6	5.4	3.1/0.35
SC903-AN-001-01	PMA42P-00100-00	80.5/9.1	80.5/9.1	36.3/4.1	31.9/3.6	2,950	4,000	13.2/6	10.6	3.1/0.35
SCE903-AN-001-01	PMA43P-00100-00	123.9/14.0	123.9/14.0	54.0/6.1	49.6/5.6	1,850	2,600	15.4/7	10.6	4.5/0.51
SC903-AN-001-01	PMA44P-00100-00	143.4/16.2	143.4/16.2	72.6/8.2	66.4/7.5	1,750	2,250	17.6/8	10.6	5.9/0.67
SC904-AN-001-01	PMA43R-00100-00	113.3/12.8	113.3/12.8	54.0/6.1	39.8/4.5	4,700	5,650	15.4/7	21.2	4.5/0.51
SC904-AN-001-01	PMA44R-00100-00	152.2/17.2	152.2/17.2	72.6/8.2	59.3/6.7	3,450	4,200	17.6/8	21.2	5.9/0.67
SC904-AN-001-01	PMA45R-00100-00	193.8/21.9	193.8/21.9	90.3/10.2	78.8/8.9	2,700	3,300	19.8/9	21.2	7.3/0.83
SC904-AN-001-01	PMA53R-00100-00	179.7/20.3	179.7/20.3	92.9/10.5	77.9/8.8	2,350	3,200	23.1/10.5	21.2	16.9/1.91
SC904-AN-001-01	PMA54R-00100-00	221.3/25.0	221.3/25.0	119.5/13.5	102.7/11.6	2,100	2,700	26.4/12	21.2	21.9/2.48
SC904-AN-001-01	PMA55R-00100-00	278.8/31.5	278.8/31.5	150.5/17.0	134.5/15.2	1,650	2,150	29.7/13.5	21.2	27.0/3.05
SC904-AN-001-01	PMA57R-00100-00	405.4/45.8	405.4/45.8	194.7/22.0	181.4/20.5	1,150	1,550	36.3/16.5	22.5	37.2/4.20
SC905-AN-001-01	PMA55S-00100-00	278.8/31.5	278.8/31.5	150.5/17.0	115.9/13.1	3,450	4,300	29.7/13.5	42.4	27.0/3.05
SC905-AN-001-01	PMA57S-00100-00	393.9/44.5	393.9/44.5	194.7/22.0	162.9/18.4	2,450	3,050	36.3/16.5	42.4	37.2/4.20
SC905-AN-001-01	PMA65S-00100-00	499.2/56.0	499.2/56.0	265.5/30.0	216.8/24.5	1,750	2,400	68.3/31	42.4	69.9/7.90
SC905-AN-001-01	PMA66S-00100-00	601.8/68.0	601.8/68.0	318.6/36.0	274.4/31.0	1,450	2,000	79.3/36	42.4	83.1/9.40
SC905-AN-001-01	PMA67S-00100-00	703.6/80.0	703.6/80.0	371.7/42.0	327.5/37.0	1,250	1,700	92.5/42	42.4	98.4/10.90
SC905-AN-001-01	PMA69S-00100-00	911.6/103.0	911.6/103.0	477.9/54.0	429.3/48.5	950	1,300	119/54	42.4	123.0/13.90
480V ac										
SCE903AN-001-01	PMA42M-00100-00	69.9/7.9	69.9/7.9	36.3/4.1	30.1/3.4	3,700	4,650	13.2/6	5.4	3.1/0.35
SCE903AN-001-01	PMA43N-00100-00	110.6/12.5	110.6/12.5	54.0/6.1	45.1/5.1	3,350	4,150	15.4/7	7.5	4.5/0.51
SCE903AN-001-01	PMA44N-00100-00	149.6/16.9	149.6/16.9	72.6/8.2	63.7/7.2	2,300	3,050	17.6/8	7.5	5.9/0.67
SCE903AN-001-01	PMA45N-00100-00	187.6/21.2	187.6/21.2	90.3/10.2	82.3/9.3	1,900	2,450	19.8/9	7.5	7.3/0.83
SCE904AN-001-01	PMA43P-00100-00	123.9/14.0	123.9/14.0	54.0/6.1	42.5/4.8	4,150	5,150	15.4/7	10.6	4.5/0.51
SCE904AN-001-01	PMA44P-00100-00	143.4/16.2	143.4/16.2	72.6/8.2	57.5/6.5	3,750	4,500	17.6/8	10.6	5.9/0.67
SCE904AN-001-01	PMA45Q-00100-00	190.3/21.5	190.3/21.5	90.3/10.2	64.6/7.3	4,000	4,750	19.8/9	15.0	7.3/0.83
SCE904AN-001-01	PMA54R-00100-00	180.6/20.4	180.6/20.4	92.9/10.5	69.0/7.8	3,350	4,450	23.1/10.5	15.0	16.9/1.91
SCE904AN-001-01	PMA54Q-00100-00	226.6/25.6	226.6/25.6	119.5/13.5	97.4/11.0	2,800	3,650	26.4/12	15.0	21.9/2.48
SCE904AN-001-01	PMA55Q-00100-00	286.8/32.4	286.8/32.4	150.5/17.0	128.3/14.5	2,200	2,900	29.7/13.5	15.0	27.0/3.05
SCE905AN-001-01	PMA53R-00100-00	179.7/20.3	179.7/20.3	92.9/10.5	59.3/6.7	4,900	6,400	23.1/10.5	21.2	16.9/1.91
SCE905AN-001-01	PMA54R-00100-00	221.3/25.0	221.3/25.0	119.5/13.5	85.0/9.6	4,400	5,450	26.4/12	21.2	21.9/2.48
SCE905AN-001-01	PMA55R-00100-00	278.8/31.5	278.8/31.5	150.5/17.0	116.8/13.2	3,450	4,300	29.7/13.5	21.2	27.0/3.05
SCE905AN-001-01	PMA57R-00100-00	405.4/45.8	405.4/45.8	194.7/22.0	164.6/18.6	2,400	3,050	36.3/16.5	22.5	37.2/4.20
SCE905AN-001-01	PMA65R-00100-00	486.8/55.0	486.8/55.0	265.5/30.0	212.4/24.0	1,900	2,600	68.3/31	22.5	69.9/7.90
SCE905AN-001-01	PMA66R-00100-00	587.7/66.0	587.7/66.0	318.6/36.0	269.9/30.5	1,600	2,150	79.3/36	22.5	83.1/9.40
SCE906AN-001-01	PMA65S-00100-00	409.3/46.2	409.3/46.2	265.5/30.0	159.3/18.0	3,650	4,800	68.3/31	33.7	69.9/7.90
SCE906AN-001-01	PMA66S-00100-00	493.5/55.8	493.5/55.8	318.6/36.0	185.9/21.0	3,000	3,950	79.3/36	33.7	83.1/9.40
SCE906AN-001-01	PMA67S-00100-00	577.0/65.2	577.0/65.2	371.7/42.0	283.2/32.0	2,550	3,400	92.5/42	33.7	96.4/10.9
SCE906AN-001-01	PMA69S-00100-00	747.5/84.5	747.5/84.5	477.9/54.0	380.6/43.0	1,950	2,650	119/54	33.7	123.3/13.90

NUMBERING SYSTEM — GLOBAL MOTOR RANGE

To construct a motor model number code, select the combination of features required and put all of the coded information in the proper sequence. Please account for an entry in each field. The model number shown is an example of a properly specified motor.

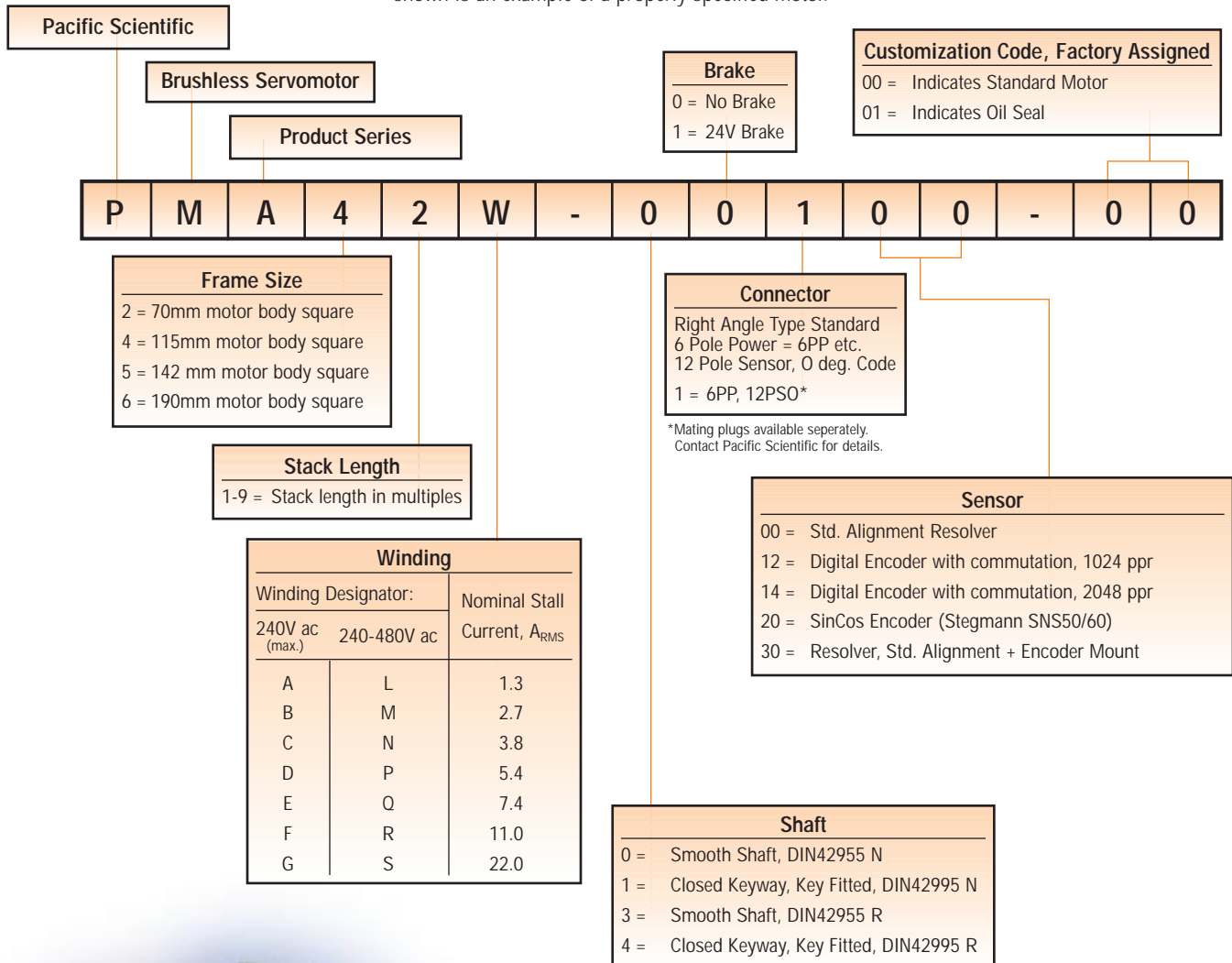

In designing the PMA series, Pacific Scientific engineers analyzed real-world motion control applications and tailored the windings for maximum efficiency using matched SCE900 and SC900 drives. The combination of Pacific Scientific motors and drives results in higher performance and efficiency, delivering more usable torque in your application.

BRAKE DATA

Motor Family	Static Torque @ 120°C		Weight		Inertia	
	lb.-in.	Nm.	lb.	Kg	lb.-in/sec ²	Kg/cm ²
	+/-30%					
PMA2	10.6	1.2	0.4	0.2	0.00011	0.12
PMA4	88.5	10	1.3	0.6	0.00097	1.1
PMA5	159.3	18	3.3	1.5	0.00319	3.6
PMA6	354.0	40	4.8	2.2	0.00841	9.5

PMA2 SERIES MOTOR

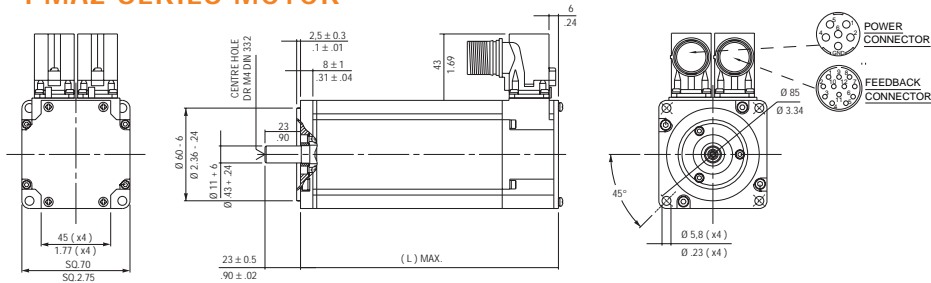

Motor	PMA21	PMA22	PMA23	PMA24
L Max	145/5.7	170/6.7	195/7.7	220/8.7

Metric dimensions in mm on top

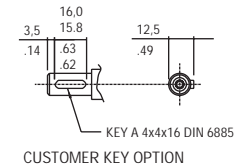

PMA4 SERIES MOTOR

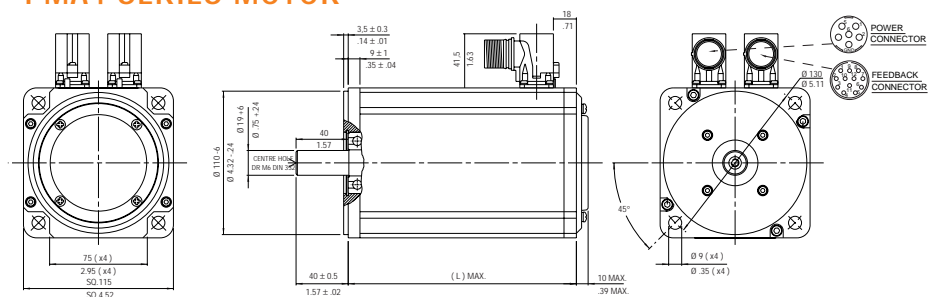

Motor	PMA42	PMA43	PMA44	PMA45
L Max	185/7.3	210/8.3	235/9.2	260/10.2

Metric dimensions in mm on top

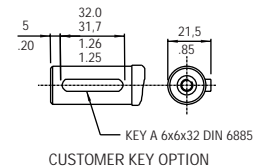

PMA5 SERIES MOTOR

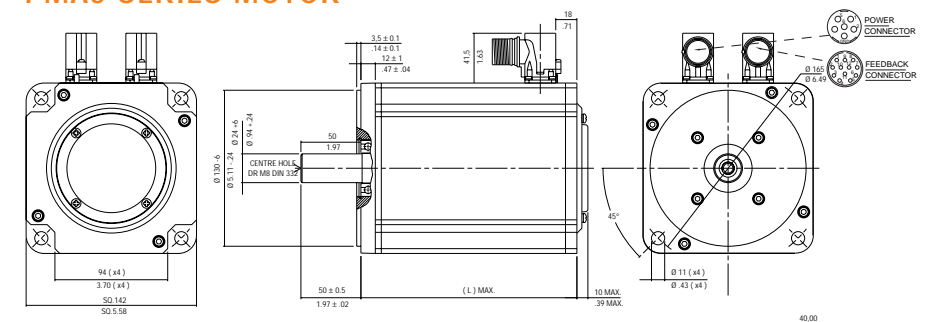

Motor	PMA53	PMA54	PMA55	PMA57
L Max	205/8.1	230/9.0	255/10.0	305/12.0

Metric dimensions in mm on top

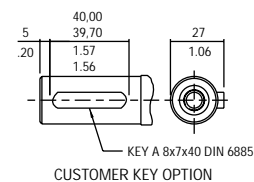

PMA6 SERIES MOTOR

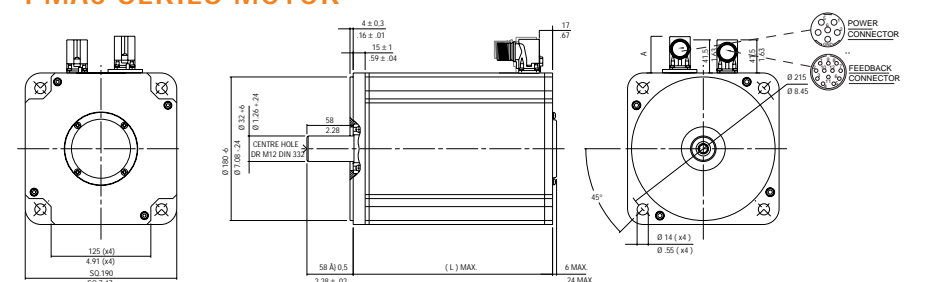

Motor	PMA65	PMA66	PMA67	PMA69
L Max	205/8.1	230/9.0	255/10.0	305/12.0

Metric dimensions in mm on top

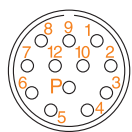
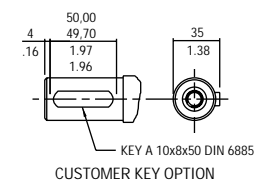

Feedback Connector	
Connector Pin	Standard Resolver
1	S1 Cos+
2	S3 Cos-
3	S4 Sin-
4	S2 Sin+
5	R1 Excit
6	R2 Excit Rtn
7	PTC
8	PTC rtn
9	not used
10	not used
11	not used
12	not used

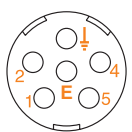

Power Connector	
Connector Pin	Motor
1	Phase U
2	Phase W
gnd	Earth Case
4	Optional Brake-
5	Phase V
E	Optional Brake+

To learn more about Pacific Scientific and our solutions for your motion control needs, call 1-888-4-PACSCI or visit our website at www.pacsci.com



HIGH PERFORMANCE MOTORS & DRIVES

4301 Kishwaukee Street, P.O. Box 106
Rockford, Illinois 61105-0106
(815) 226-3100 Fax (815) 226-3080

Locations:
Rockford, IL Ennis, Ireland
Wilmington, MA Frankfurt, Germany
Broomfield, CO

New Addition!

The Comprehensive Line of Rugged, Cost-Effective Servomotors is Now Larger (and Smaller)



THE NEW PMA1 SERIES BRUSHLESS SERVO MOTORS

Pacific Scientific's PMA Series is industry's most rugged, comprehensive line of cost-effective brushless servomotors available. Now, with the addition of the new PMA1 series motors, the family gets bigger - and smaller.

This motor family extends Pacific Scientific's commitment to offering you the highest performance, backed by unmatched quality and customer support, tailored to your applications.

These compact motors feature a 55 mm square frame, in three stack lengths. A continuous rated torque range from 0.21 to 0.6 Nm, optional sealing to IP67, CE compliance and the capability of integral parking brake give these motors the flexibility to meet your application.

Part Number Configurator - PMA1 Series

To construct a motor model number code, select the combination of features required and put all of the coded information in the proper sequence. Please account for an entry in each field. The model number shown is an example of a properly specified motor.

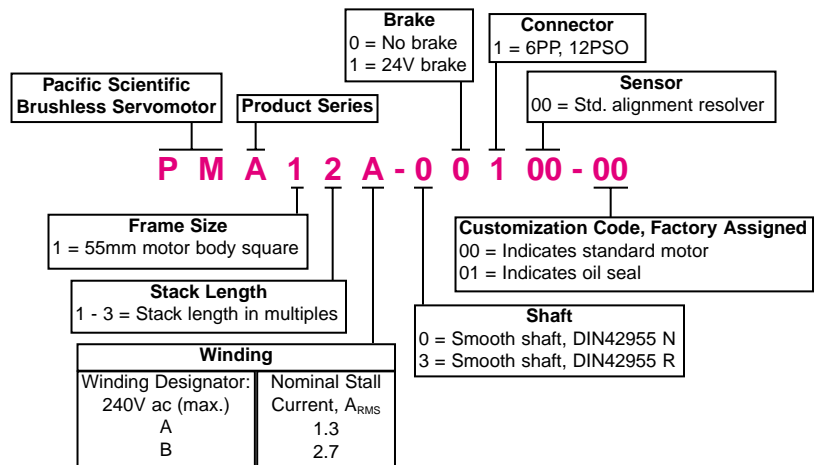

In designing the PMA1 Series, Pacific Scientific engineers analyzed real-world motion control applications and tailored the windings for maximum efficiency using matched PC832, SC902 and SCE902 drives. The combination of Pacific Scientific motors and drives results in higher performance and efficiency, delivering more usable torque in your application.



Dimensions

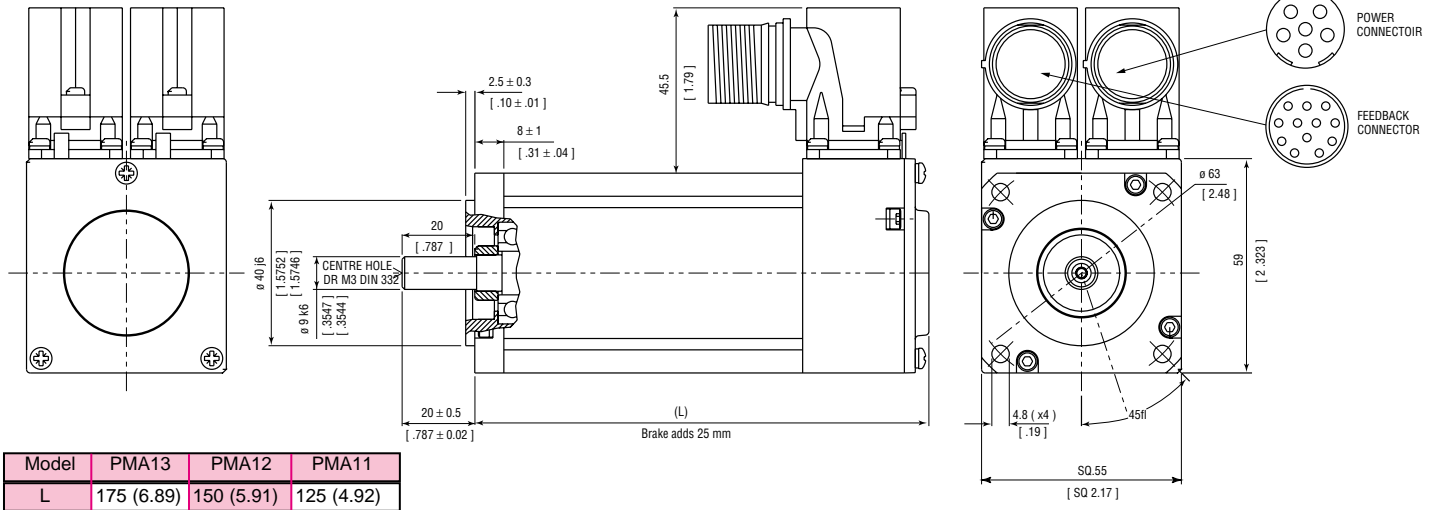

Drive & Motor Performance Data

In the table below, we show the performance data for the recommended combinations of PMA1 motors and PC832, SC902 or SCE902 drives. In addition to continuous stall current (I_{CS}), inertia (J) and line-line inductance (L), each system has ratings provided that enable you to construct a reference chart to compare and size systems. The ratings required to construct the chart are:

- Peak Stall Torque (T_{PS})
- Peak Rated Torque (T_{PR})
- Continuous Stall Torque (T_{CS})
- Continuous Rated Torque (T_{CR})
- Rated Speed (W_R)
- Unloaded Motor Speed (W_{NL})

Test Conditions

Motor operated at rated winding temperature of $\Delta T = 100^\circ\text{C}$ above ambient, at 25°C ambient.

- Intermittent duty zone
- Continuous duty zone

Example Chart

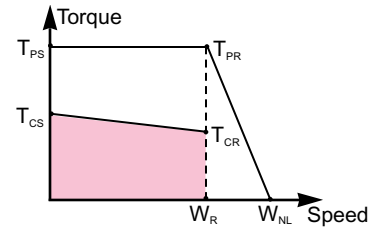

Servo Motor Model	Servo Drive Model	Peak stall torque T_{PS} Nm/lb-in.	Peak rated torque T_{PR} Nm/lb-in.	Cont. stall torque T_{CS} Nm/lb-in.	Cont. rated torque T_{CR} Nm/lb-in.	No-load speed W_{NL} rpm	Rated speed W_R rpm	Continuous stall current I_{CS} A	Current at peak torque I_{PS} A	Inertia $\times 10^{-3}$ J kgm ² /lb-in-S ²	Inductance line-line L mH
PMA11A	PC8x2,SC,SCE9x2	1.4/12.4	1.4/12.4	0.26/2.3	0.21/1.9	7,000	12,900	0.96	5.4	0.012/0.102	7.1
PMA12A	PC8x2,SC,SCE9x2	1.7/15.0	1.7/15.0	0.6/5.3	0.48/4.2	8,500	10,800	1.88	9.4	0.019/0.164	4.3
PMA13B	PC8x2,SC,SCE9x2	1.8/15.5	1.8/15.5	0.9/8.0	0.6/5.3	9,000	10,600	2.73	13.8	0.026/0.226	2.7

To construct a chart, plot the points as shown in the example. Note that the chart provides continuous and intermittent duty zones.

Systems can be operated continually at torque/speed combinations anywhere in the continuous duty area, assuming the ambient temperature is less than 40°C .

Operation in the intermittent duty zone must be limited to a duty cycle, which will produce an RMS system torque falling within the continuous duty area. The RMS torque value is defined by the magnitude of the intermittent torque and the percentage of time spent at that torque.

Brake Data

Motor Family	Static Torque @ 120°C		Weight		Inertia	
	Nm	lb-in.	kg	lb.	kg/cm ²	lb-in-sec ²
PMA1	±30% 1.2	10.6	0.2	0.4	0.12	0.00011

To learn more about Pacific Scientific and our solutions for your motion control needs, call **1-800-4-PACSCI** or visit our website at **www.pacsci.com**.



HIGH PERFORMANCE MOTORS & DRIVES

4301 Kishwaukee Street, P.O. Box 106
Rockford, Illinois, 61105-0106
(815)-226-3100 Fax (815) 226-3080

Locations:

Rockford, IL
Wilmington, MA
Ennis, Ireland

JL91423 00-5-1.5M